

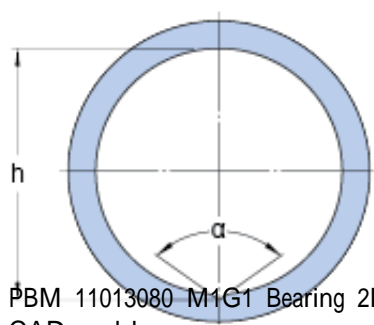

# BEARING INDUSTRIA CUSCINETTI S.P.A.

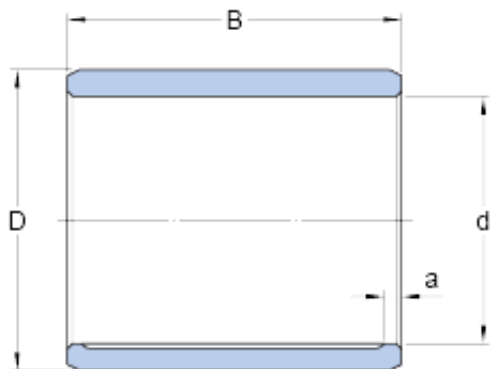

PBM 11013080 M1G1 Bearing 2D drawings and 3D CAD models

110 mm x 130 mm x 80 mm skf PBM 11013080  
M1G1 Plain bearings, Bushings

Bearing No. PBM 11013080 M1G1

d	110 mm
D	130 mm
B	80 mm
a	4 mm
h	111.5 mm
	124 °
Tolerance shaft	e7
Tolerance housing	H7
Specific dynamic load factor K	25 N/mm <sup>2</sup>
Specific static load factor K <sub>0</sub>	45 N/mm <sup>2</sup>
Permissible sliding velocity v min.	0 m/s
Permissible sliding velocity v max.	0.5 m/s
Coefficient of friction μ min.	0.08
Coefficient of friction μ max.	0.15
Mass bushing	2.65 kg